

SB-HARDY〈Vials-3〉

精密鋁水平尺



ALUMINUM BOX LEVELS

- To avoid bending by internal protruding line and special formed body as a box shape.
- Surface has been treated by powder coating with no pollutional materials.
- Clear and shock-proof vials are never broken to measure even it is given an impact.
- Additional 45° vials can be used for multi-purpose measuring instruments.
- Used for woodworks and other normal measuring works.

型號	規格	單位	單價
HYV3-12	12"(300m/m)	支	300 00
HYV3-15	15"(375m/m)	支	360 00
HYV3-18	18"(450m/m)	支	380 00
HYV3-24	24"(600m/m)	支	450 00
HYV3-36	36"(900m/m)	支	520 00
HYV3-40	40"(1000m/m)	支	590 00
HYV3-48	48"(1200m/m)	支	690 00
HYV3-60	60"(1500m/m)	支	830 00
HYV3-72	72"(1800m/m)	支	990 00
HYV3-80	80"(2000m/m)	支	1,100 00

SB-HARDY〈Magnetic〉

磁動鋁水平尺



ALUMINUM BOX LEVELS WITH MAGNETIC

- To avoid bending by internal protruding line and special formed body as a box shape.
- Surface has been treated by powder coating with no pollutional materials.
- Clear and shock-proof vials are never broken to measure even it is given an impact.
- Powerful magnet in the body makes to stick on the object perfectly.
- Used for steelworks, welding and construction works with general steel items.

型號	規格	單位	單價
HYMV3-12	12"x(300m/m)	支	410 00
HYMV3-15	15"x(375m/m)	支	460 00
HYMV3-18	18"(450m/m)	支	480 00
HYMV3-24	24"(600m/m)	支	540 00
HYMV3-36	36"(900m/m)	支	720 00
HYMV3-40	40"(1000m/m)	支	840 00

SB-COMBI〈Vials-3〉

SB-PARTNER〈Vials-3〉

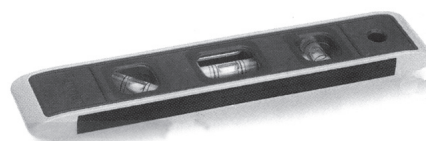

型號	規格	單位	單價
CIV3-9	9"(230m/m)	支	320 00

型號	規格	單位	單價
PRV3-9	9"(230m/m)	支	190 00



MANITOU

ELECTRONIC DIGITAL CALIPER

DIGITAL CALIPERS 數字顯示卡尺

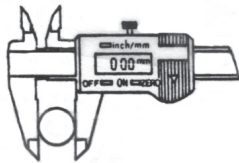

規格 Measuring Range	分辨率 Resolutio ⁿ	精度 Repeatability	單價
0-150mm/6"	0.01mm/.0005"	0.01mm/.0005"	2,400 00
0-200mm/8"	0.01mm/.0005"	0.01mm/.0005"	3,200 00
0-300mm/12"	0.01mm/.0005"	0.01mm/.0005"	5,000 00

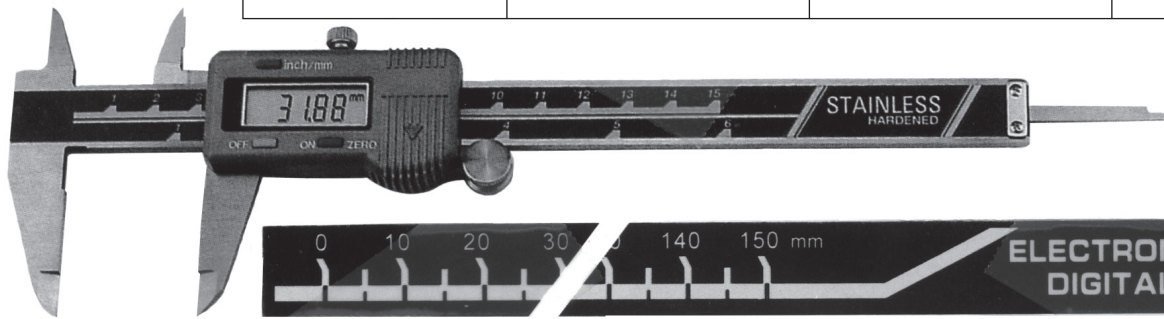

卡尺・標準ノギス

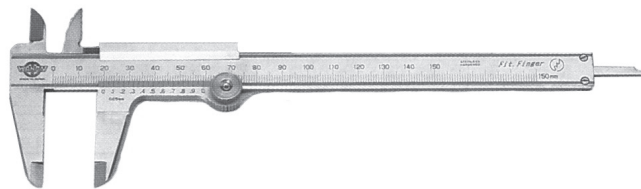

- 指かけ部分がロックになっている世界唯一のワンタッチシステム
- 止めネジが上部にありませんから、特に内側測定の時、邪魔になりません。
- 紛失の心配がない、脱落防止機構のロックボルトナット。
- 上下2本の本尺側溝は目盛面の乱反射作用を軽減し、目が疲れません。
- 4種類の測定が可能な多機能ノギス。

ノギスの角をカットした手に優しいフィットフィンガータイプですから手が疲れません。目に優しい緑色のライン入りですので目が疲れません。

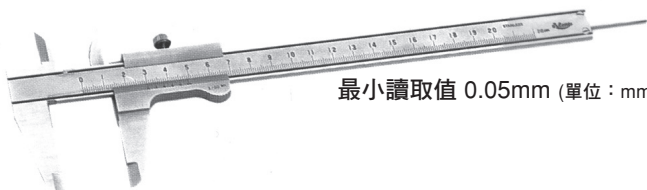

最小讀取値 0.05mm (單位: mm)

- 最も一般的に使われているノギスです。
- 外側、内側、深さの測定ができます。
- 600mmまではデップスパー付です。

標準卡尺

規格	單位	單價
150m/m × 6" × 0.05	支	500 00
200m/m × 8" × 0.05	支	700 00
300m/m × 12" × 0.05	支	1,400 00



數字顯示厚薄計
DIGITAL THICKNESS GAGES

型號 order No.	測量範圍 Measuring Range	精度 Resolution	單位	單價
213-101	0-10mm	0.01mm/.0005"	支	4,800 00
213-101S	0-10mm/4"	0.01mm/.0005"	支	6,700 00

Laserlevels 高精密雷射水平儀 MAYER 德國製

機械裝置，建築，水工，室內設計等均適用

Protective cover: For LL80 and LL80PRO. Made of waterproof and dustproof fabric, 80 cm long.
Order No.: 021.11.20.2



Tripod: Highly stable tripod of natural wood and metal, can be set up on metal spikes or rubber stoppers. Centimetre scale to ensure equal length of the tripod legs. Max. extension height: 152 cm; with rapidly adjustable 31 cm central piece for precise height adjustment. Transport length: 79 cm. 1/4" thread for optimum tripod base plate attachment. Weather-resistant.
Order No.: 021.64

Tripod bracket: Can be fitted on any tripod with a 1/4" photo thread.
Order No.: 021.60

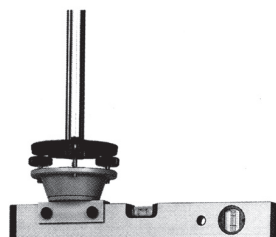

Ceiling leveller: The height-adjustable telescopic rod enables height specifications to be met without difficulty. Extension height (40 - 68 cm). The ceiling leveller can be used in conjunction with all Laserliner models. Complete with 1/4" thread tripod base, telescopic rod and ceiling adapter.
Order No.: 021.69



Universal base: The universal base is an accessory for the Laserliner junior. It is an invaluable aid for laying wall and floor tiles and general alignment work.
Order No.: 021.61.15.1

Laserpads: 25 x 75 mm (5 pcs.), for use as reflection markers over bigger distances.
Order No.: 020.10.30.2

Laserliner. With good accessories, the scope of applications extends beyond the horizon.



Rotary Tripod base: With the three finely adjustable screws, horizontal alignment of the Laserliner is easy and precise. High stability for near-ground working and 1/4" thread attachment for photo tripods or 5/8" attachment for building tripods.
Order No.: 1/4" thread 021.68
5/8" thread 021.68.9-1



Beam splitter: Generates a horizontal beam and a perpendicular reference plane. Beam splitter - pentaprism with 360° rotation. Right angle with 30" precision (0.15 mm/m)
Order No.: 021.71

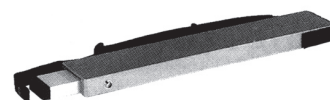

Professional case: Silver metallic hardwood case with adjustable shoulder strap. Robust, weatherproof storage and transport container for the Laserliner precision spirit levels. Laser switches off automatically when put in the case. Additional compartment for 2 spare batteries and the prism adapter.



90° prism adapter: For highly accurate beam deflection through 90°. Generates a vertical reference plane. Pentaprism with 360° rotation. Right angle with 30" precision (0.15 mm/m)

品名	規格及用途	單位	單價
1/4" 螺紋專業三腳架	超穩固三腳架，原木 金屬拼製，腳身劃置公分刻度以確保均衡三腳等長，最大延伸高度 152cm	架	9,100 00
迴旋三腳架座盤 Rotary Tripod Base XNT	1/4" , 5/8" 螺紋 穩定 優，適宜低地面座用，附三只調節螺絲 配用 1/4" 螺紋攝影三腳架或 5/8" 螺紋建築三腳架	只	5,900 00
天花板水準儀 Ceiling Leveller	高度隨意調節遠嵌棒，可視高度調節碰觸頂點 延伸高度 40-68cm，可配合所有雷射劃線儀使用	組	9,100 00
萬用座盤 Universal Base	提供迷你雷射儀 (LL Junior) 附著於牆壁或地板磁磚	只	800 00
保護套 Professional Case	40cm/80cm長 銀色金屬硬木混合製，可調式肩帶，既耐用又防惡	只	1,900 00

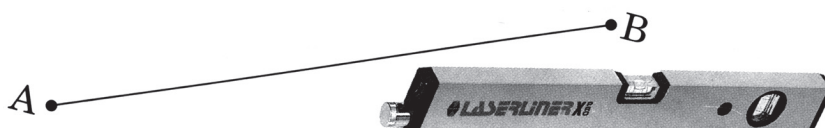

Laserlevels 高精密雷射水平儀

機械裝置，建築，木工，室內設計等均適用

MAYER 德國製

品名	規格/用途說明	單位	單價
組立高級雷射劃線儀 LL40XPRO Top Set	90-180度兩用散光投射器，座盤，攜帶盒	組	23,600 00
組立標準雷射劃線儀 LL40PRO Classic Set	90度投射器，座盤，攜帶盒	組	19,600 00
雷射劃線儀 LL40XPRO	水平誤差 0.25mm/M，波長 650-655nm 特殊明亮雷射光，長 40cm，雷射範圍：50M 可加置 90度投射器和 90-180度兩用散光投射器	支	13,700 00
雷射劃線儀 LL40PRO	水平誤差 0.5mm/M，波長 650-655nm 特殊明亮雷射光，長 40cm，雷射範圍：50M 可加置 90度投射器和 90-180度兩用散光投射器	支	11,500 00
雷射劃線儀 LL80PRO	水平誤差 0.5mm/M，波長 650-655nm 特殊明亮雷射光，長 80cm，雷射範圍：50M 可加置 90度投射器和 90-180度兩用散光投射器	支	12,000 00
雷射劃線儀 LL80	水平誤差 0.5mm/M，波長 670nm，長 80cm，範圍：20M 無加置 90度投射器和 90-180度兩用散光投射器	支	7,900 00
迷你雷射劃線儀 LL Junior	用以安置於精密水準儀或直尺上 長 12cm，波長 670nm，雷射範圍：20M	支	7,200 00
90度投射器 90° Prism Adapter	垂直 90度，鑄造垂直水平雷射 可 360度轉，直角精確值 30度 (0.15mm/M)	只	3,900 00
90/180度兩用散光投射器 90° Beam Splitter	可同時投射 90度和 180度雷射 可 360度轉，直角精確值 30度 (0.15mm/M)	只	6,700 00
測視眼鏡	雷射光點清晰目視眼鏡 Laser Glasses	付	2,300 00

4 Laserliners. 4 levels of Performance. All of high quality.

